

# Should You Add DNA Testing to Your Genealogic Armamentarium?

---

Trudy Burns

Iowa City Genealogical Society

June 27, 2009



# Outline

---

- International Society of Genetic Genealogy
- Overview of basic genetic concepts
- Why does genetic genealogy focus on the Y chromosome and mitochondrial DNA?
- DNA testing companies
- Haplotypes and haplogroups
- Public genealogy testing projects and databases



# International Society of Genetic Genealogy (ISOGG)

---

- Founded in 2005
- Mission includes: educating others about the use of genetics in genealogy through workshops, the website ([www.isogg.org](http://www.isogg.org)), speaker's bureau, forums, and meetings
- Non-commercial, non-profit organization, there are no dues or fees to join, it is entirely self-supporting by its members
- Membership is over 6,000 with members residing in: Algeria, Australia, Bahamas, Barbados, Belgium, Bermuda, Bosnia & Herzegovina, Brazil, Bulgaria, Canada, Czech Republic, Colombia, Costa Rica, Croatia, Curaçao, Cyprus, Denmark, Egypt, England, Finland, France, Germany, Greece, Hungary, India, Ireland, Israel, Italy, Japan, Luxembourg, Malaysia, Mariana Islands, Mexico, Mongolia, Namibia, Netherlands, New Zealand, Northern Ireland, Norway, Philippines, Portugal, Russia, Scotland, South Africa, Spain, Saint Vincent and The Grenadines, Seychelles, Sweden, Switzerland, Taiwan, Thailand, Trinidad & Tobago, Tunisia, Turkey, Wales, United Arab Emirates, United States, and Venezuela

# Structure of a Cell

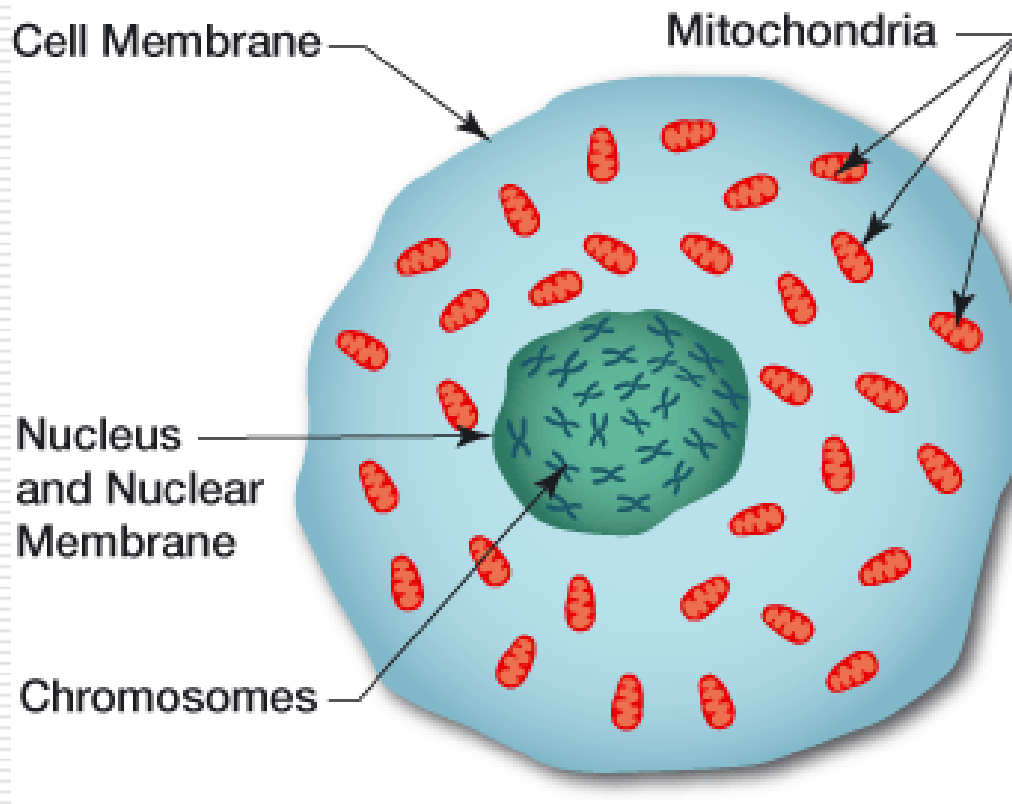

- Most of the cells in our body have a nucleus that contains a copy of our DNA
- Red blood cells do not have a nucleus; white cells do, and they are the most frequent source of DNA
- Mitochondrial DNA is outside the cell nucleus in the cytoplasm

# 23 Pairs of Nuclear Chromosomes

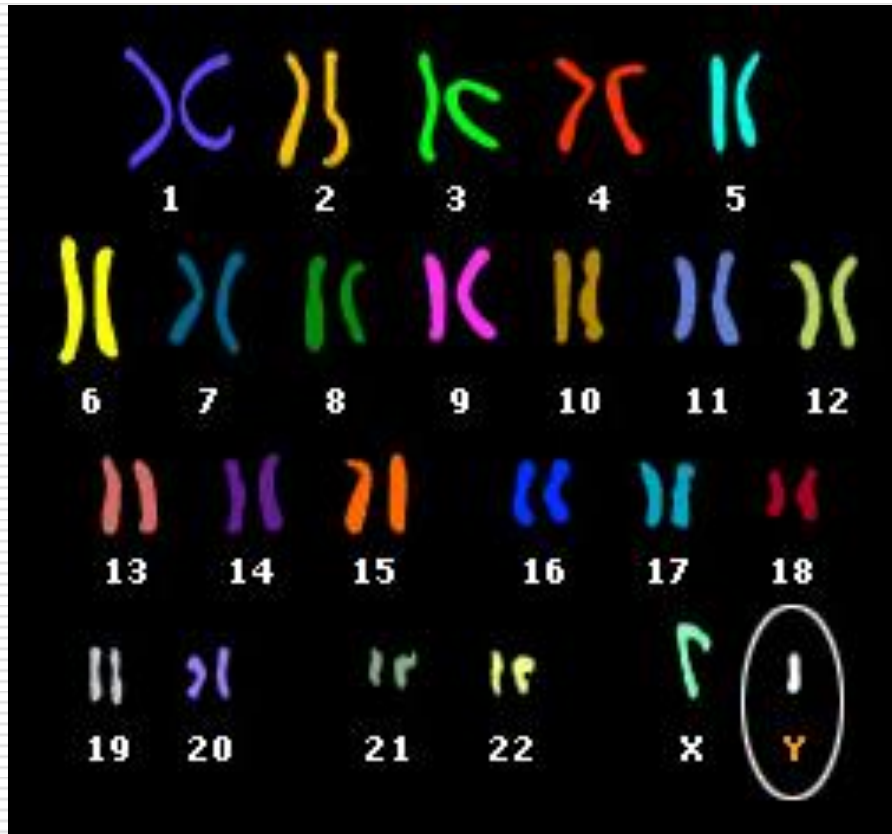

- Most cells contain 23 pairs of chromosomes in their nucleus, one member of each pair is inherited from the mother, and the other is inherited from the father
- These are the nuclear chromosomes
- The X and Y chromosomes constitute the 23<sup>rd</sup> pair

# Sex Chromosome Pairs

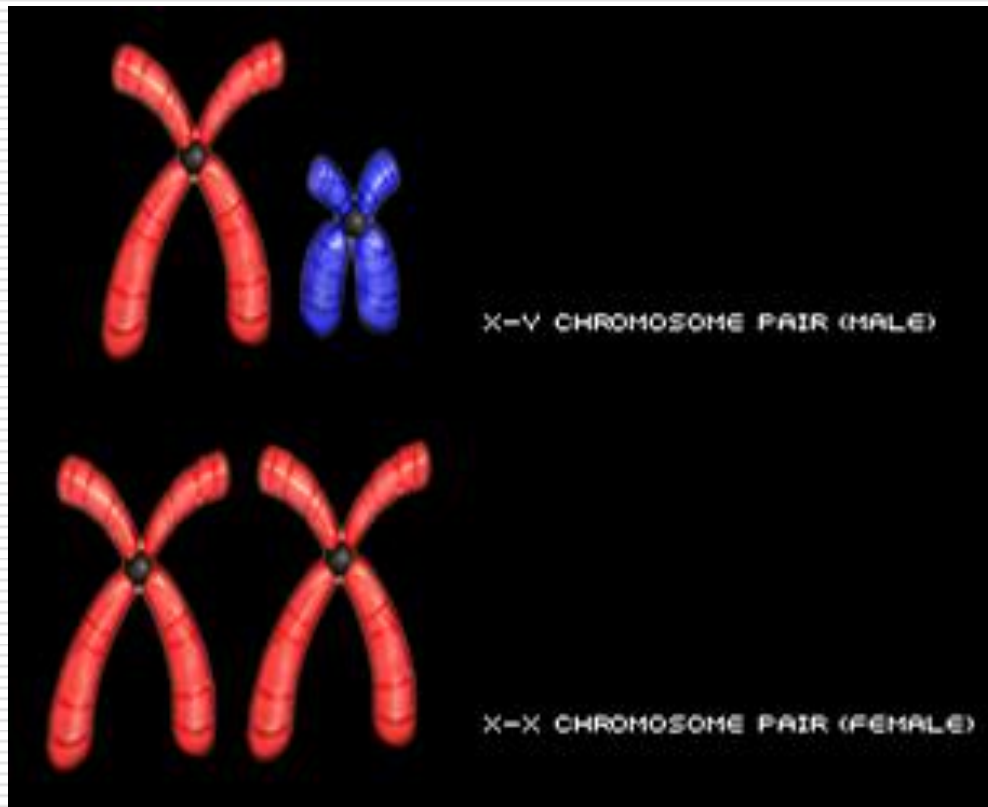

- Males have one X chromosome (inherited from their mother) and one Y chromosome (inherited from their father)
- Females have two X chromosomes
- The Y-chromosome is passed intact from fathers to their sons

# Human Life, from a Nuclear Chromosome Viewpoint

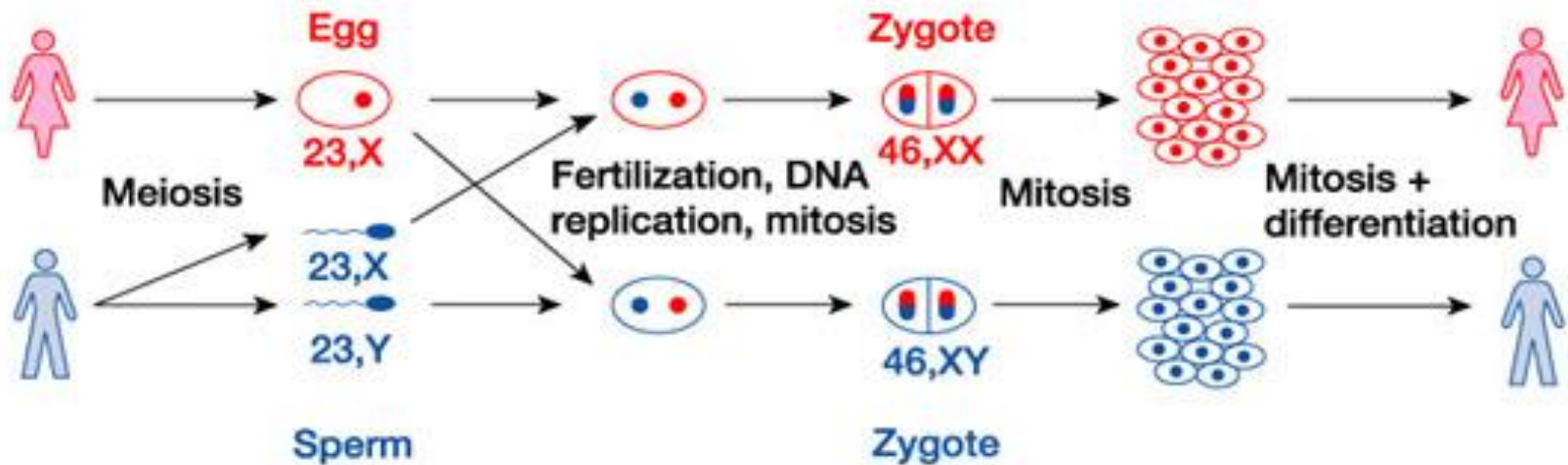

Figure 2.2 from Human Molecular Genetics 3<sup>rd</sup> Edition

Mitosis is the process by which the body grows, differentiates, and replaces dead or injured cells – a human being has  $\approx 10^4$  cells

One cell divides and produces two cells genetically identical to the parent cell



# Mitochondrial DNA (mtDNA)

---

- mtDNA consists of one circular chromosome which is much smaller than the smallest nuclear chromosome
- Each cell contains 2 to 100 mitochondria and each mitochondrion in the cell cytoplasm contains 5 to 10 copies of this chromosome
- A mother transmits her mtDNA sequence to all her children, male and female
- Each sibling shares their mtDNA with their mother, sisters, brothers, maternal aunts and uncles, maternal grandmother and her brothers and sisters, and so on
- It may not be identical at all loci because of new mutations



# Meiosis

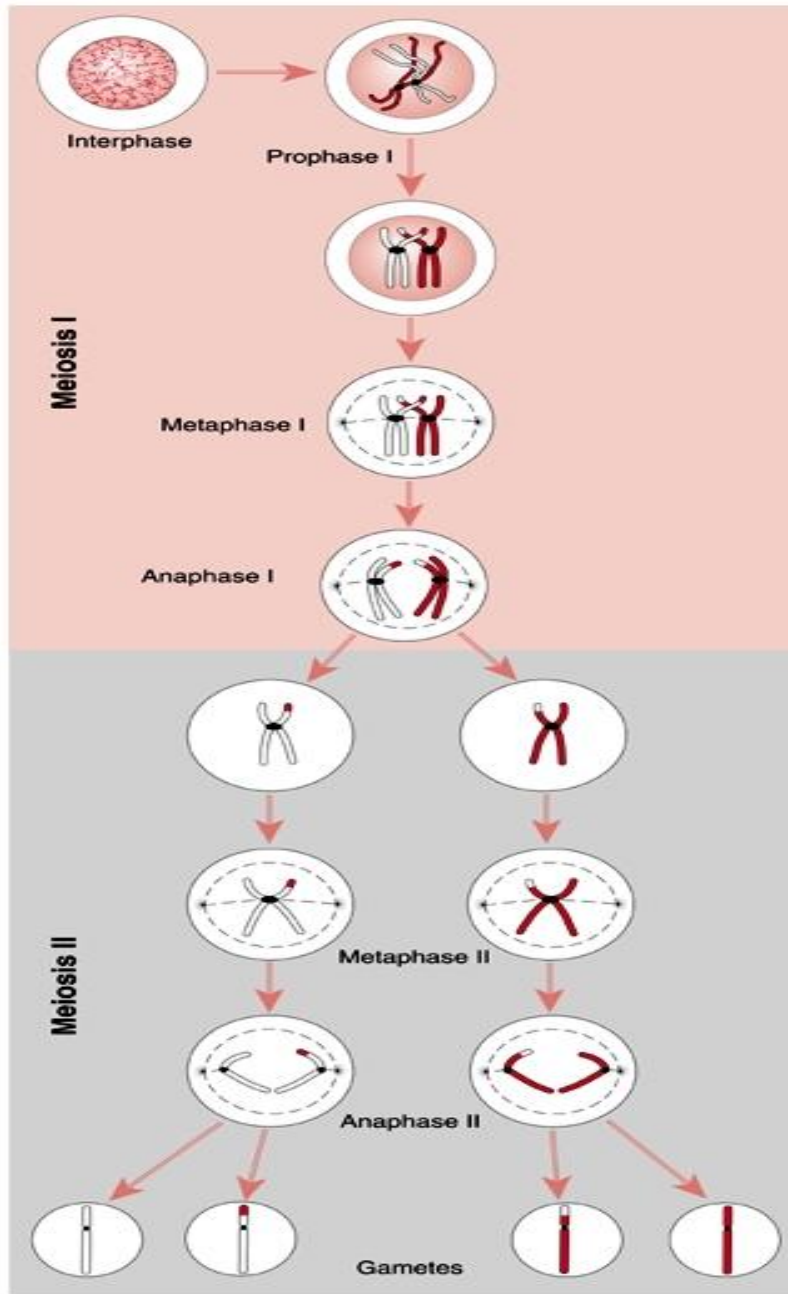

- A special type of cell division by which eggs and sperm are formed
- Each cell formed has one representative of each chromosome pair, so 23 chromosomes
- Mature sperm contain very little of the cytoplasm of the cell, therefore, the inheritance of mitochondrial DNA is through the maternal line

# Crossovers during Meiosis – Genetic Shuffling

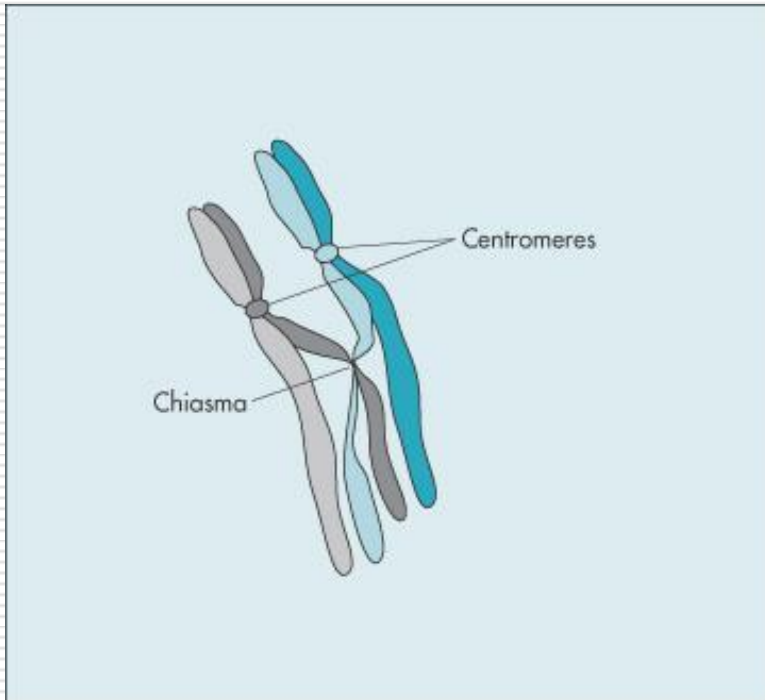

© 2003 Mosby, Inc. All rights reserved.

A Nuclear Chromosome Pair

- The genome of each individual represents a vast tapestry of the DNA of their ancestors
- Mitochondrial DNA is passed nearly intact from mothers to their sons and daughters (matrilineal descent)
- The Y-chromosome is passed intact from fathers to their sons (patrilineal descent)
- Crossovers shuffle the DNA of the other 22 nuclear chromosomes – combination of maternal and paternal DNA

# Y-Chromosome and mtDNA Inheritance

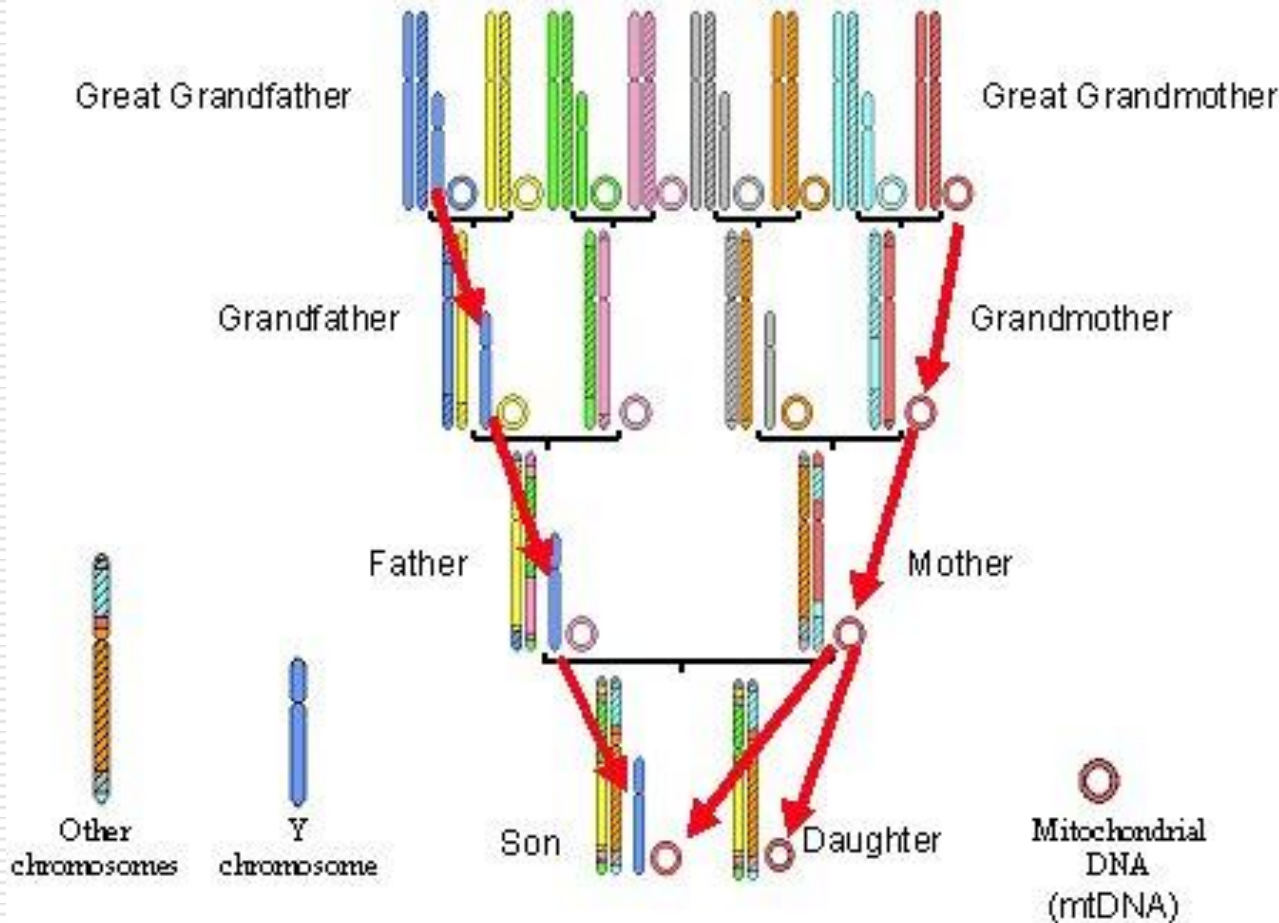

Notice the "tapestry" of the longer chromosomes that represent chromosomes 1 through 22 and the X chromosome

The Y chromosome and the mitochondrial DNA are the same in the four generations



# The "Double Helix" Structure of DNA

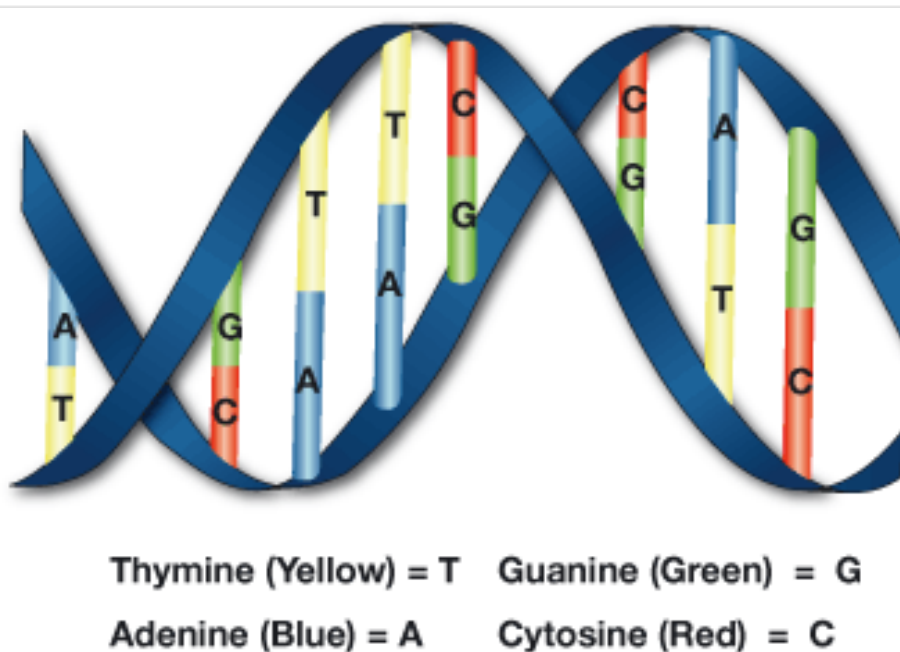

[www.familytreedna.com](http://www.familytreedna.com)

- DNA is composed of four bases:
  - Adenine (A)
  - Cytosine (C)
  - Thymine (T)
  - Guanine (G)
- G always pairs with C, and A always pairs with T
- The "human genome sequence" is the list of bases along one of the strands of the chromosomes



# The Human Genome

---

- The human genetic code (genome) is 99.9% identical throughout the world
- What's left is the DNA responsible for our individual differences – in eye color or disease risk, for example,
  - along with DNA that serves no apparent function at all



# The Base-Pair Sequence Contains Genetic Information

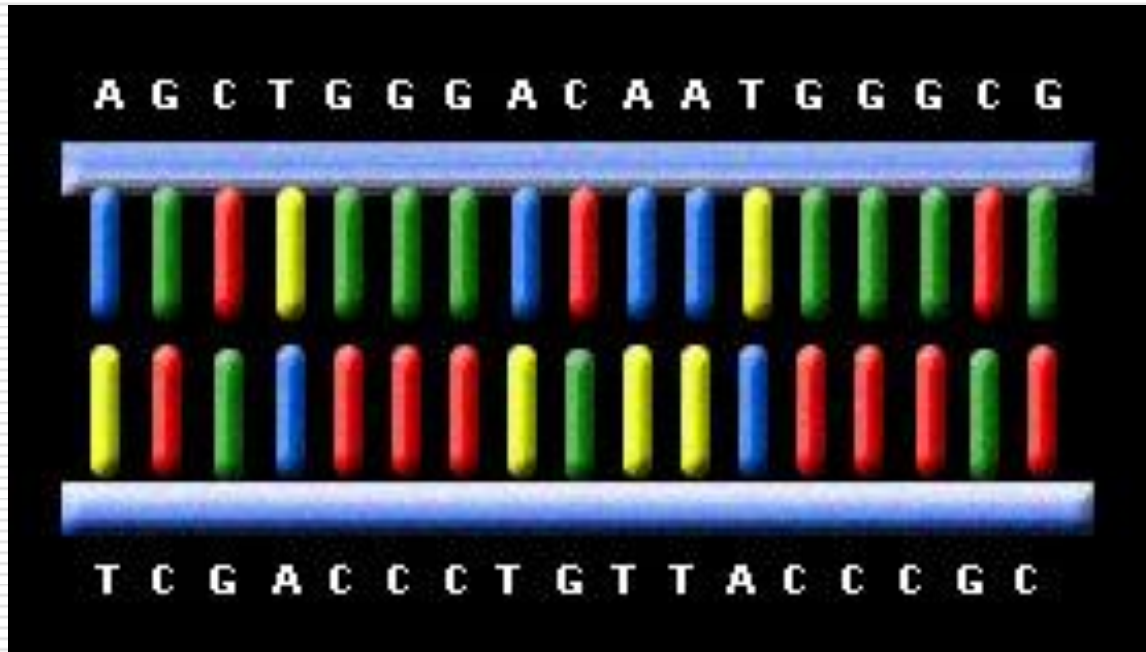

When “flattened,” DNA looks like a ladder – the two sides are the “backbone” of the DNA and the rungs are the “bases” A, C, T and G

[www.dnaancestryproject.com](http://www.dnaancestryproject.com)

The unique sequence of As, Cs, Ts, and Gs forms the “genetic code” that carries genetic information, and differences in the sequence that are consistent among relatives can be utilized for genetic genealogy

# Changes in the DNA Sequence

---



- Random, harmless changes (mutations) can occur in non-coding regions (introns) of the genome, i.e., in regions that are not part of the DNA that codes for gene products like enzymes
- These changes are rare, but when they happen, they are passed down to that person's descendants
- Generations later, finding that same change, "marker," in the DNA from two individuals indicates that they likely share a common ancestor
- By comparing markers in many different populations, it is possible to trace ancestral connections



# Changes in the mtDNA Sequence

---

- The mitochondrial chromosome is 16,569 bases in length
- The mutation rate of mtDNA is 20 times higher than that of nuclear DNA, and thus mtDNA is extremely variable from one family to the next
- Mutations have accumulated in mtDNA throughout human evolution
- Portions of the mitochondrial chromosome do not code for any genes, mutations have accumulated without deleterious effect in these regions – called HVR1 and HVR2 - these are the most variable regions of the entire human genome
- As a result, each maternal lineage has a mtDNA sequence that is nearly, or even completely, unique





# Short Tandem Repeat (STR) Markers

- “Hypervariable” regions are portions of the DNA sequence where the same short sequence of bases is repeated over and over again
- For example, the sequence ACT  
ACTACTACTACT
- Mr. Brown has more repeats than Mr. Jones, who has more repeats than Mr. Smith
- The number of repeats varies among individuals
- The number of repeats is heritable



# Inheritance Pattern of an STR Marker

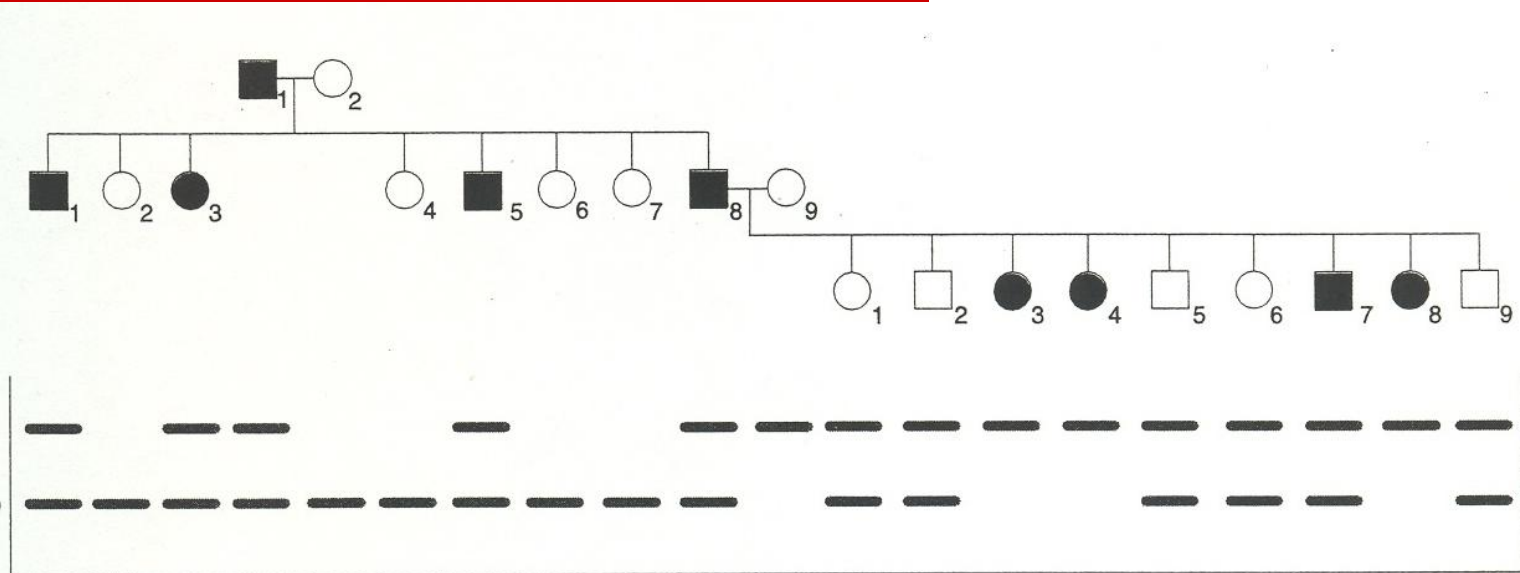

- An STR marker on an autosomal chromosome (1 through 22)
- Family members with two bands, have a different number of repeats on each the two chromosomes, e.g., chromosome 17
- Pedigree members with one band have the same number of repeats on each of the two chromosomes



# DYS19 Marker on the Y Chromosome Repeat Sequence is TAGA

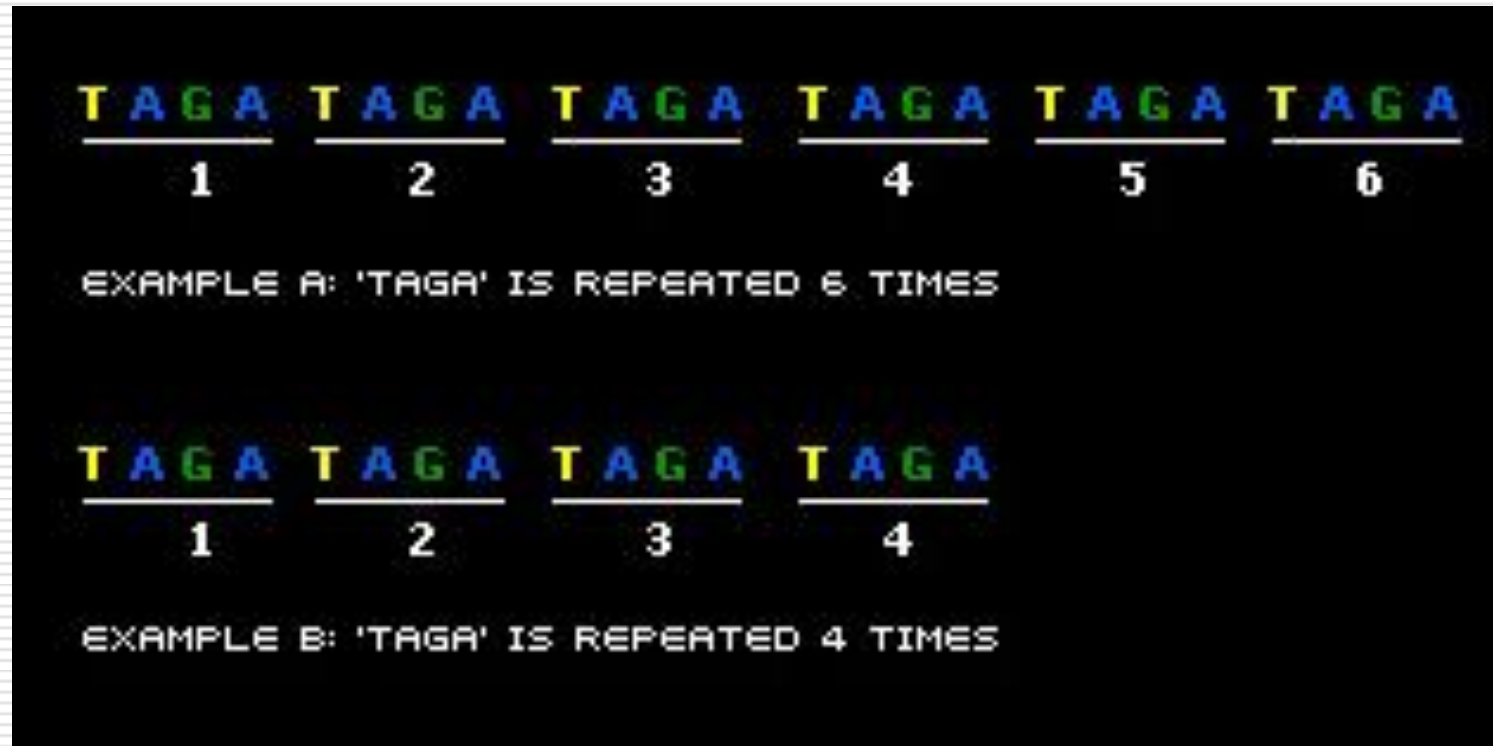

[www.dnaancestryproject.com](http://www.dnaancestryproject.com)

DNA test results indicate the number of repeats, Y-chromosome STR markers are used to test more recent ancestry



# DNA Changes Can be Used as a Genealogic Clock

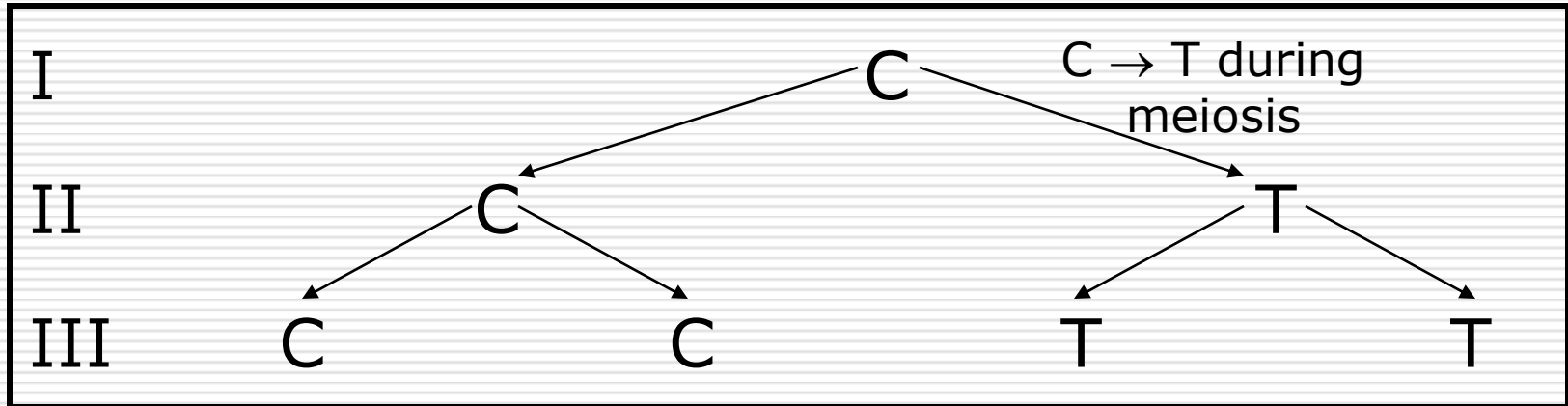

- This type of change in the DNA sequence, called a “single nucleotide polymorphism” (SNP), can be used to mark the location (locus) in the genome where individuals in generations II and III differ
- Millions of these markers have been identified and each one has a unique identification number
- “Unique Event Polymorphisms” are SNPs that have occurred only once
- These SNPs can be used to define haplogroups – ancient ancestry



# DNA Test Kits – Buccal Cell Brushes or Saliva Container



Saliva is spit into the DNA collection container

Capping the container releases DNA-preserving fluid which then mixes with the saliva

DNA is now stable at room temperature until it is analyzed at the lab



# DNA Testing Companies

---

- Many companies (> 40) now sell DNA test kits:
  - Family Tree DNA in Houston, established in 2000
  - Oxford Ancestors in England, established in 2000
- Prices for mtDNA testing range from \$129 to \$495, and prices for Y-DNA testing range from \$169 to approximately \$360, depending on the extent of genotyping
- See a list of companies with testing and cost comparison charts: <http://www.isogg.org/mtdnachart.htm> and <http://www.isogg.org/ydnachart.htm>
- 23andMe in California, [www.23andme.com](http://www.23andme.com)
- deCODEme in Iceland, [www.decodeme.com](http://www.decodeme.com)



# DNA Tests have Limitations

---

- They show only small slices of genetic history
- Y-DNA tests
  - analyze the Y chromosome that is passed virtually unchanged for generations from father to son
  - examine one branch of a family tree – the male line – a father's, father's, father, etc.
- Mitochondrial DNA tests
  - analyze mitochondrial DNA that is passed from a mother to all of her children
  - follow only the direct female line

# 2<sup>4</sup> = 16 Ancestors Four Generations Back

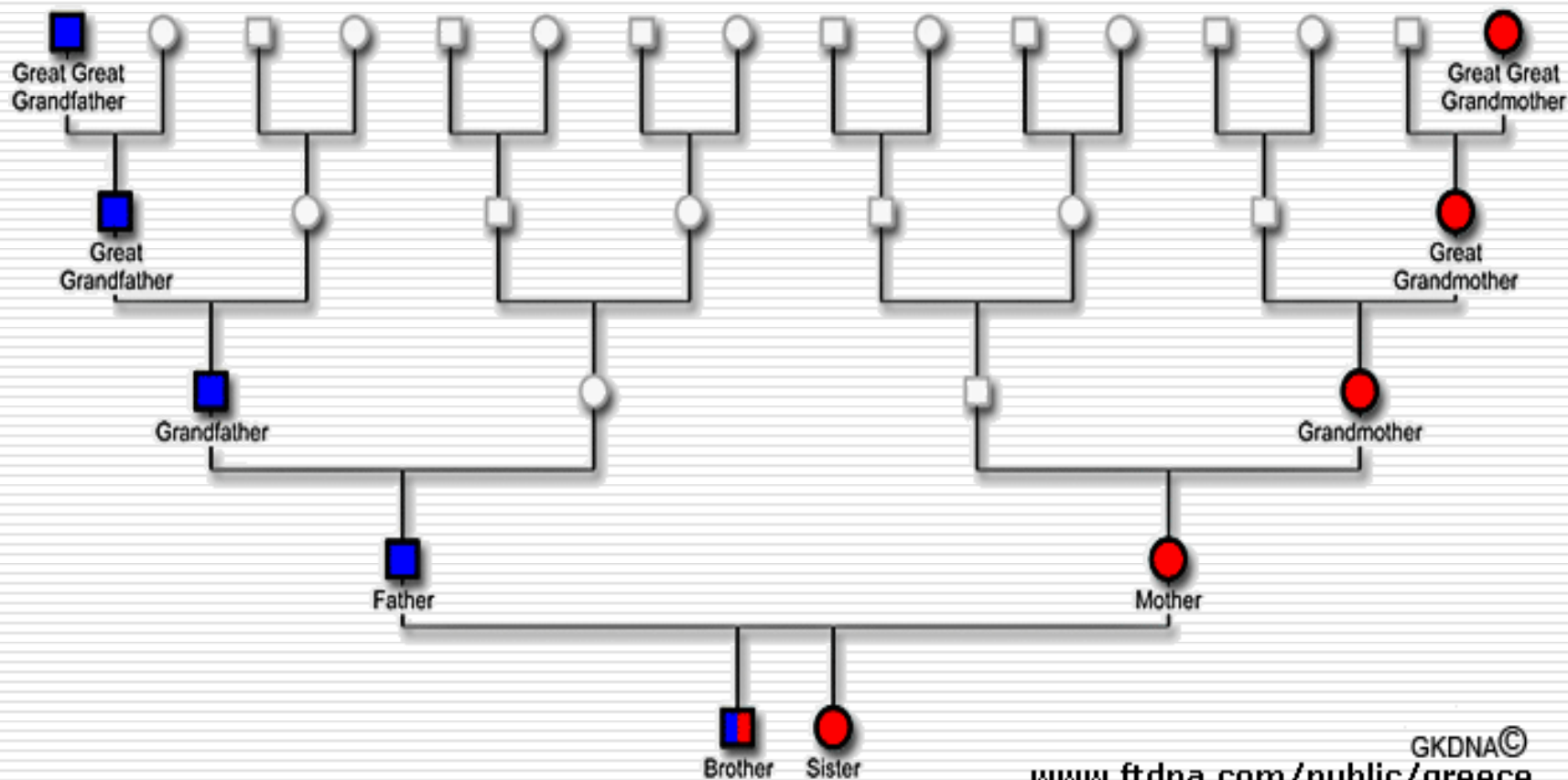



## Y-DNA Inheritance Descendants Chart (Paternal Line)

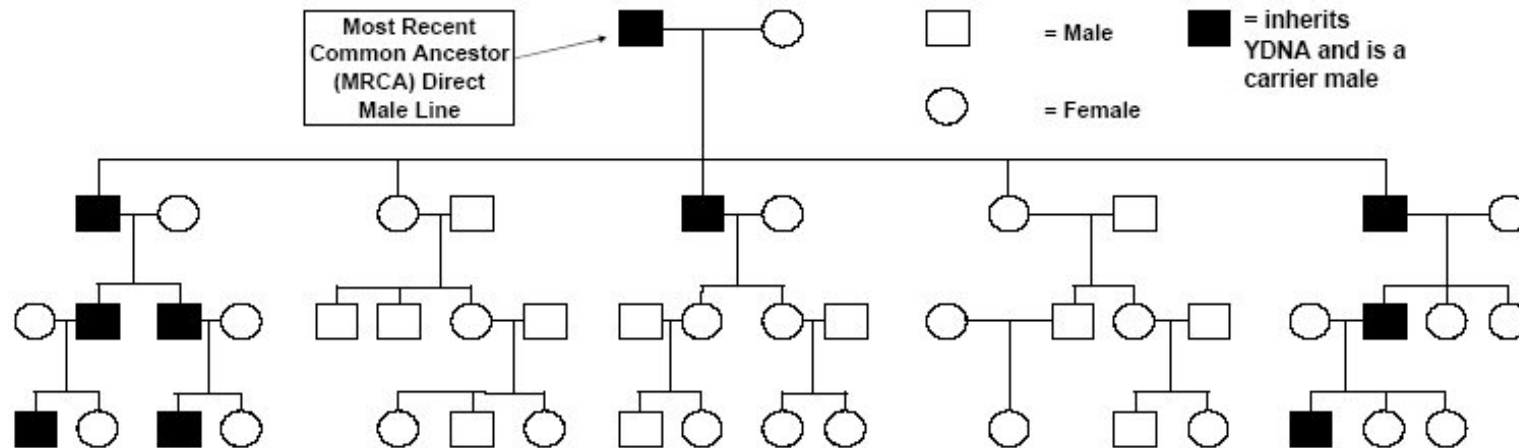

Copyright © 2002-2007 Charles F. Kerohner, Jr. All Rights Reserved.

## Mt-DNA Inheritance Descendants Chart (Maternal Line)

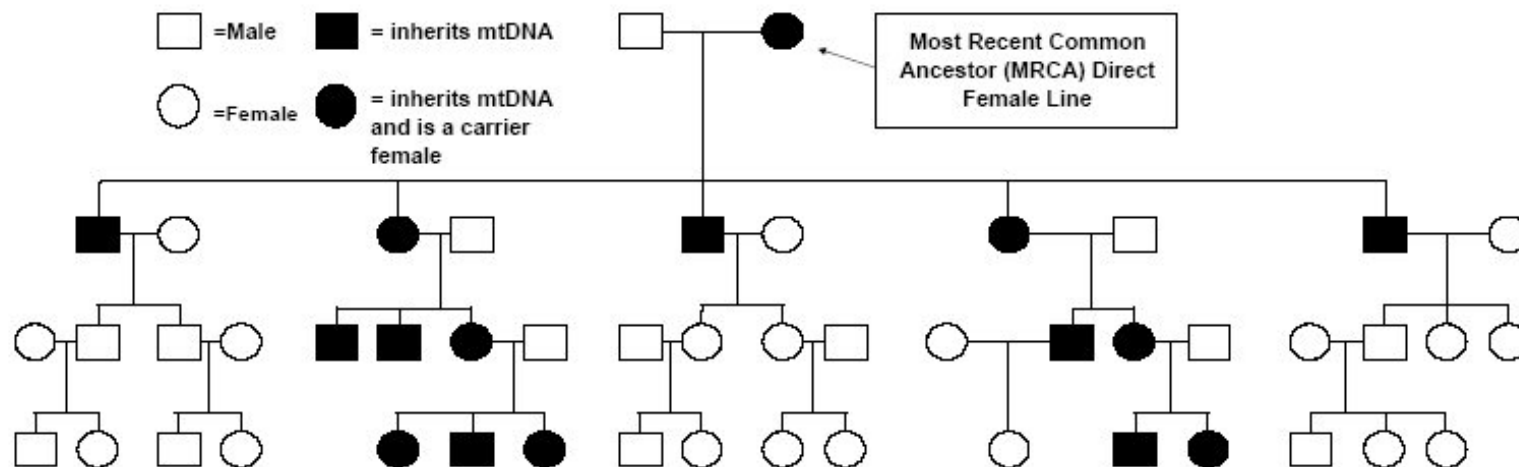

Copyright © 2002-2007 Charles F. Kerohner, Jr. All Rights Reserved.



# Go Back Just 10 Generations

---

- About 300 years
  - You have 1,024 ( $= 2^{10}$ ) ancestors in that 10<sup>th</sup> generation
    - The Y chromosome test tells you about only one male ancestor in that generation
    - The mitochondrial test tells you about only one female ancestor in that generation
- So, you need to pay attention to what DNA tests can and cannot tell you

# Before Initiating the DNA Testing Process

---



- Be sure you are requesting the best test for the person who will provide the DNA sample: take some time to look at your family tree and consider what you are looking for from a test to ensure that you order the best test
- Select the right person to test: think about whether the person has the same Y-Chromosome or mitochondrial DNA as the ancestor who interests you
- Choose the right company: do not spend your money without fully understanding what you are getting



# What is a Haplotype?

---

- Your haplotype is a set of numbers and/or letters obtained from testing your DNA for a set of SNP and/or STR markers
- The letters and/or numbers represent the test results
- For example, a Y-DNA test that uses STR markers might produce results that look like this: DYS393=13, DYS390=24, DYS394(aka19)=14, DYS391=11, DYS385a=11, DYS385b=16, DYS426=12, DYS388=12, DYS439=12, DYS389-1=13, DYS392=13, DYS389-2=29, etc., where the numbers represent the number of repeats at each location
- There is a consensus mtDNA sequence (Cambridge Reference Sequence - CRS)
- A mtDNA test might produce results that look like this: 16162G, 16519C, 73G, 263G, 309.1C, 315.1C, where the letters represent the base at the loci that differ from the CRS

# Y-DNA Test

## 25-Marker Haplotype



Locus	DYS#	Alleles
1	393	13
2	390	24
3	19*	14
4	391	11
5	385a	11
6	385b	14
7	426	12
8	388	12
9	439	12
10	389-1	13
11	392	13
12	389-2	29
13	458	17
14	459a	9
15	459b	10
16	455	11
17	454	11
18	447	24
19	437	15
20	448	19
21	449	30
22	464a**	15
23	464b**	15
24	464c**	17
25	464d**	17

- These marker data do not mean much by themselves
- They need to be compared to the marker data of other individuals that have been genotyped by the company
- You may need to recruit other people with the same surname



# Time to The Most Recent Common Ancestor (TMRCA)

---

- Basic Idea: individuals that match at a higher fraction of Y-chromosome markers are more closely related
  - Estimate of the number of generations two different Y chromosomes are from a common ancestor
  - When mutations occur in STRs, the number of repeats changes, e.g., from fourteen to thirteen or fifteen
  - This happens on the order of 1 mutation every 500 generations



# TMRCA for 12-, 25-, 37- and 59-Marker Tests

- Perfect matches of two Y chromosomes for different numbers of markers
- For a given probability (percent), the number of generations decreases with an increase in the number of markers tested
- Not an exact science

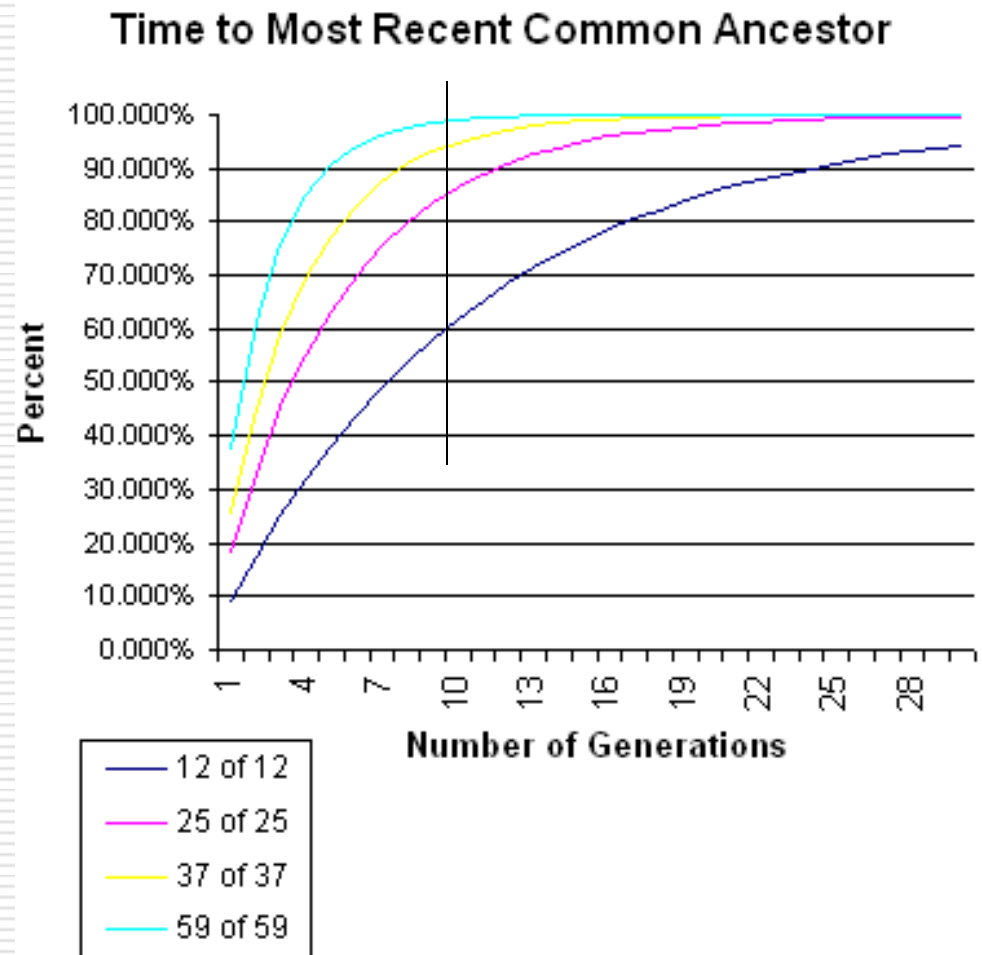



# Effect of Mismatches on the Number of Generations to MRCA

# of Matching Markers	50% probability that the MRCA was no longer than this number of generations	90% probability that the MRCA was no longer than this number of generations	95% probability that the MRCA was no longer than this number of generations
10 of 12	16.5	56	72
11 of 12	17	39	47
12 of 12	7	23	29
35 of 37	6	12	14
36 of 37	4	8	10
37 of 37	2 to 3	5	7





# What are Haplogroups?

---

- All humans have a past that traces back to Africa
- Over thousands of years, different groups have traveled and settled around the world
- Each group has its own path and history recorded in DNA
- Part of that record is found on the Y chromosome
- SNP changes that are discovered on the Y chromosome are placed on the Y chromosome Consortium's (YCC) phylogenetic tree
- This tree can then be used to explore our own shared past and place our, or a representative relative's, Y chromosome in the context of these historic migrations

# Y-DNA Haplogroups – Human Migration Map

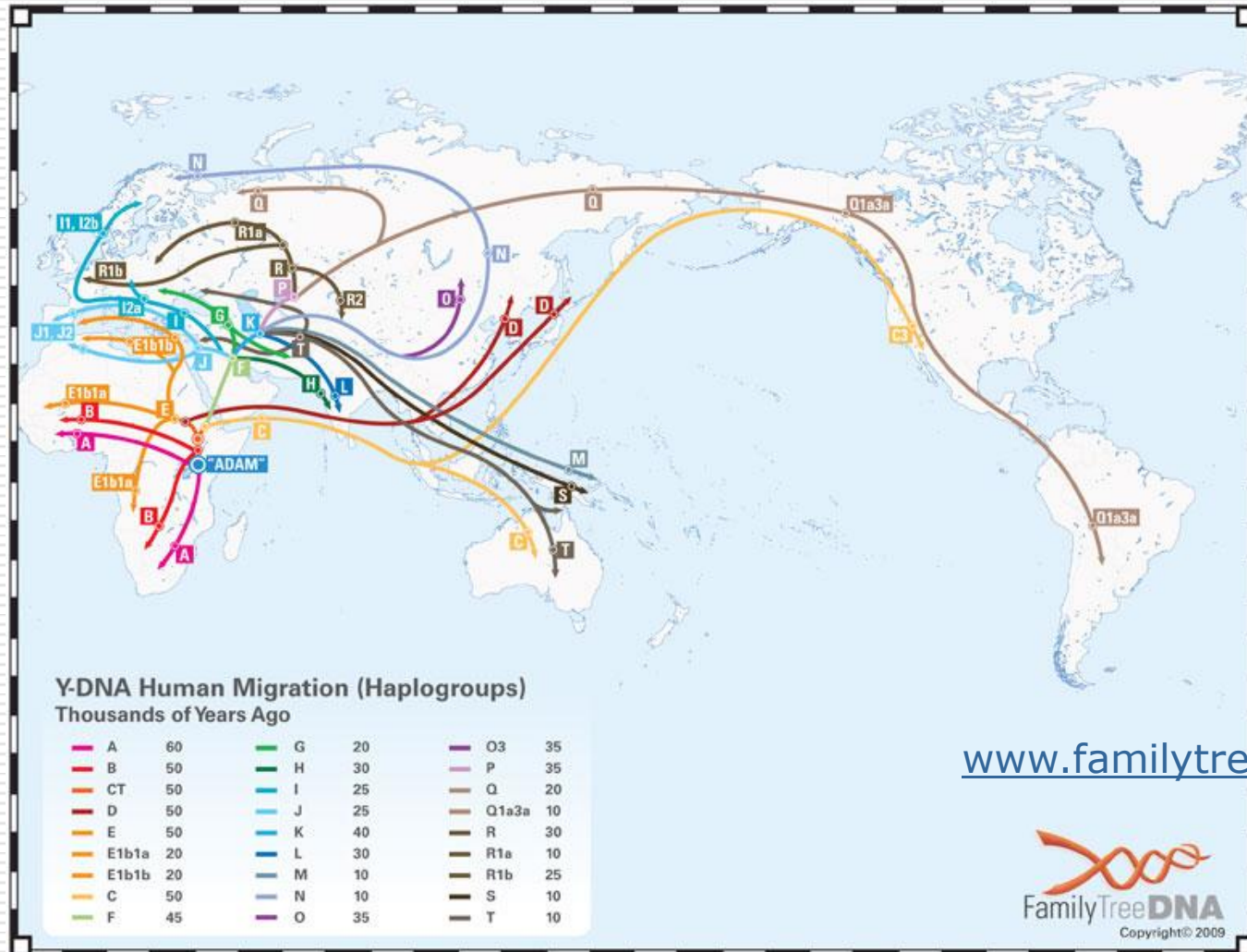

# Y-DNA Haplogroups

- Haplogroups are the major branches on the Y-chromosome tree, each different SNP marks a new branch
- A haplogroup identifies an individual's major population group and provides information about the ancient origin of the male line
- Each of the major haplogroups has numbered subgroups that are named with alternating letters and numbers

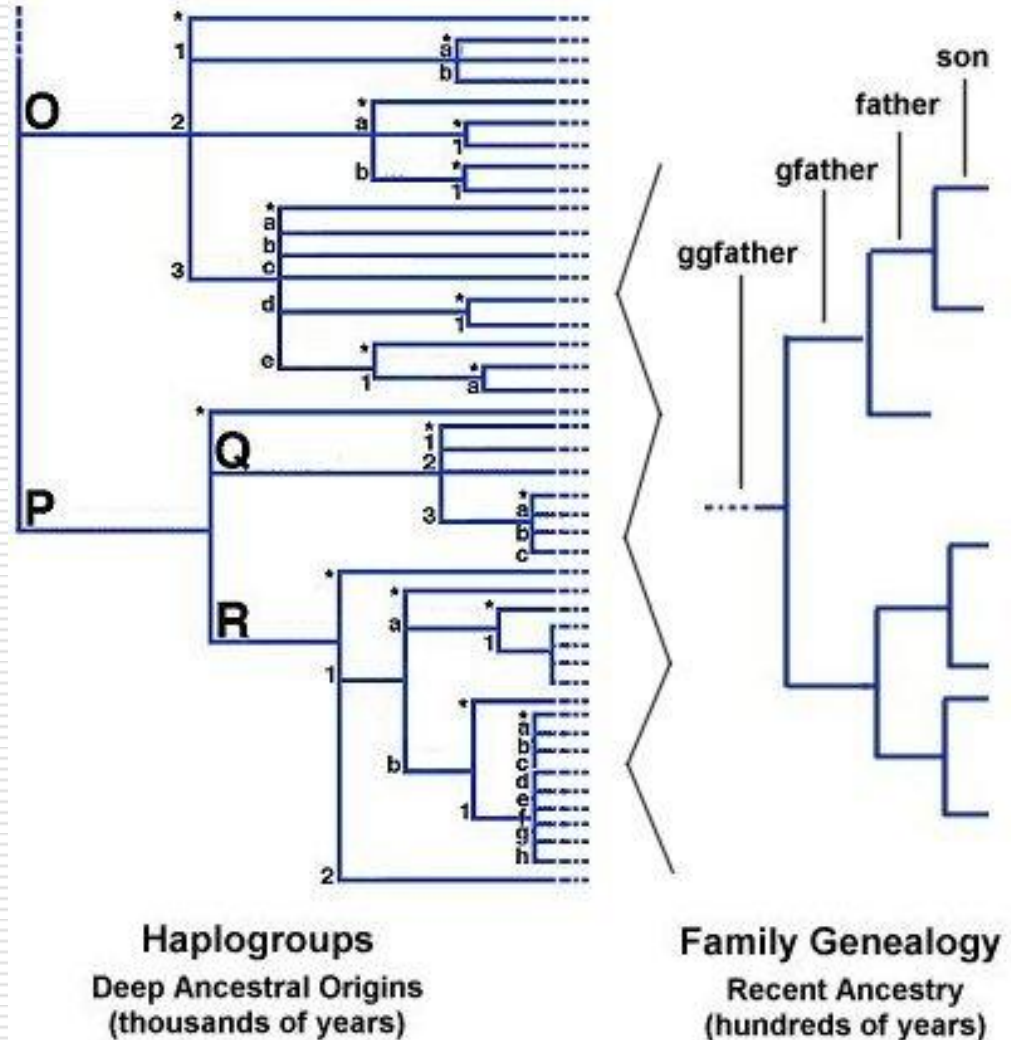



# Haplogroup Q

- All haplogroups descend from a single Y chromosome carried by a man that lived in the distant past
- Haplogroups are defined by SNPs that have accumulated as Y chromosomes are passed from fathers to sons over many generations
- As more SNPs are discovered, the structure of the tree changes, for example, haplogroup Q

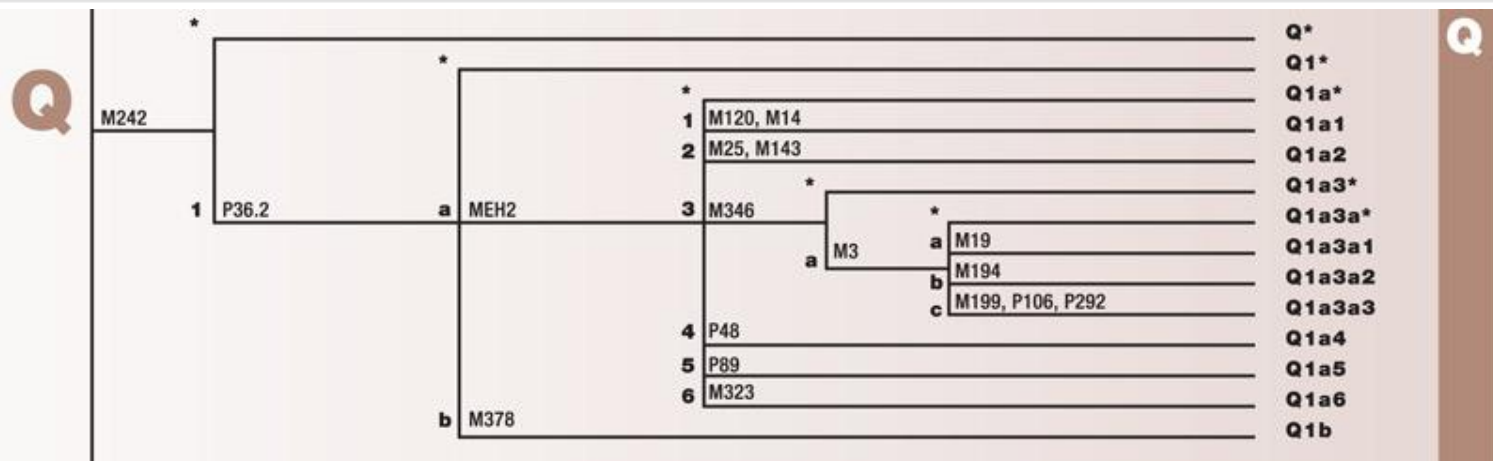



# Haplogroup Q

---

- Haplogroup Q is one of two branches of the mega-haplogroup P
- Q originated approximately 20,000 years ago in Central Asia
- Its branches have migrated into both Europe and East Asia
- Some of its branches took part in the settlement of the Americas
- These branches make up the majority of pre-Columbian Amerindian populations

# mtDNA Haplogroups – Human Migration Map

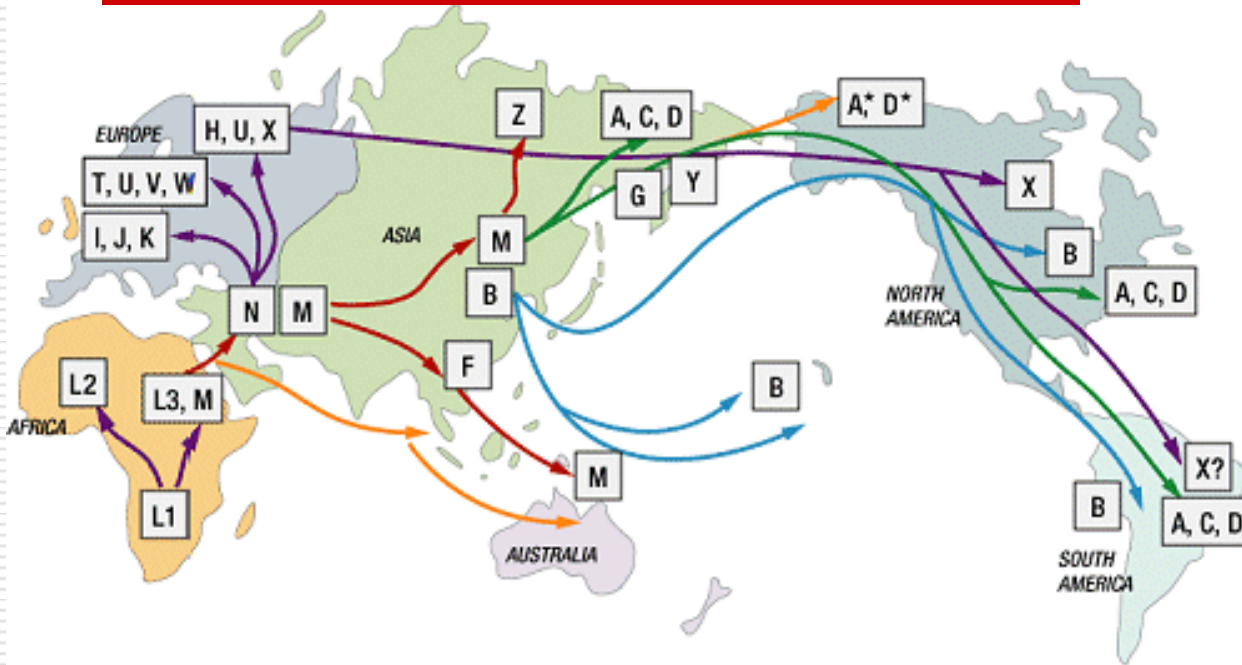

mtDNA haplogroups have been identified that originated in Africa, Europe, Asia, the Islands of the Pacific, and the Americas

[www.familytreedna.com](http://www.familytreedna.com)

## EXPANSION TIMES (years ago)

Africa	120,000 - 150,000
Out of Africa	55,000 - 75,000
Asia	40,000 - 70,000
Australia/PNG	40,000 - 60,000
Europe	35,000 - 50,000
Americas	15,000 - 35,000
Na-Dene/Esk/Aleuts	8,000 - 10,000



# ysearch

SEARCH BY  
LAST NAME

CREATE A  
NEW USER

SEARCH FOR  
GENETIC MATCHES

EDIT AN  
EXISTING USER

SEARCH BY  
HAPLOGROUP

ALPHABETICAL LIST  
OF LAST NAMES

RESEARCH TOOLS

STATISTICS

A Free Public Service from [Family Tree DNA](#)

[Need Help?](#)

[Forgot Password?](#)

[Disclaimer](#)

<http://www.ysearch.org>

## Welcome

Much has happened since Y-DNA testing first became available commercially through [Family Tree DNA](#) in February of 2000. Many thousands of people have tested to find family connections as well as family origins. Since then, other labs have entered this market, and the number of tested individuals is growing as the use of DNA is becoming more and more accepted as an important tool for family research, enhancing traditional genealogy research methods.

In order to allow people that have tested with the different companies to make their results available for comparison, [Family Tree DNA](#) is offering Ysearch as a free public service. We have added several tools that allow you to compare side-by-side different users - the [YsearchCompare](#) - as well as generate a [Genetic Distance™ Report](#), and many other features, including the upload of GEDCOM files.

**Have you not tested yet? Order your test at [Family Tree DNA](#)**

**Have you not tested with Family Tree DNA? Check this [very special deal!](#)**

**Already have an account? Please [upload your GEDCOM](#). ([What is a GEDCOM?](#))**

### What next?

- ▶ [Create a new user](#)
- ▶ [Search for genetic matches](#)
- ▶ [Search by last name](#)
- ▶ [Edit an existing user](#)

### Size of the database?

- ▶ Surname Count: 55422
- ▶ Unique Haplotypes: 55828
- ▶ Number of Records: 73310
- Family Tree DNA - 64727
- Relative Genetics - 1021
- Oxford Ancestors - 335
- Other - 7227

June 25, 2009



# Ybase: genealogy by numbers

[Demo](#)
[Home](#)
[Submit](#)
[Search by Haplotype](#)
[Search by Surname](#)
[Edit](#)
[Lost password?](#)
[Haplo-matic](#)
[Statistics](#)
[Convert](#)
[Help](#)

[Multiple Submit](#)
[Quick Search](#)
[Alphabetical List](#)

★ Great news for those researching surnames with Y-chromosomes!! Click [here](#) for details.

<http://www.ybase.org>

Welcome to **Ybase**, an open, global resource for genealogists.

Find your genetic cousins worldwide - independently of which testing service you have used.

The database is searchable on an unrivalled **49** Y-chromosome markers, making it the broadest, most open database around.

Anyone can add to it. Anyone can search it. (and it's free thanks to those nice people at [DNA Heritage!](#))

Ybase currently contains **14660** haplotypes and over **10795** unique surnames.



**Search by surname**



**Submit**



**Search by haplotype**



**Multiple Submit**



**Maps**

Europe North America



**Statistics**

Please note: to follow up a genetic link, only contact other individuals if you have an exact or close match on at least 20 markers AND the same or similar surname.

Without these pre-requisites, it is unlikely that you would be related.